

BRAVO **300**

---

***USE AND MAINTENANCE***

***SPRAY CONTROL***

GB

Software No. 54

---

CE

**46730X**

---

**ATTENTION!**

This device is for controlling the ARAG general, section and adjustment valves installed on agricultural machines used for weeding and spraying.

Please read the instructions contained in this handbook carefully. ARAG cannot be held liable for damage caused by improper installation or use.

This equipment comes within the limits provided for by EN 50081-1 and EN 50082-1 concerning radio-frequency interference.

**PRECAUTIONS!**

In order to safeguard the functionality of the BRAVO30X the following instructions must be observed:

- Do not spray water on the equipment.
- Do not use solvent or benzenes to clean the outer parts of the container.
- Observe the foreseen power supply voltage (12 Vdc).
- When arc welding, make sure the BRAVO30X power supply is disconnected. If necessary, disconnect the leads of the tractor battery.
- Use only genuine ARAG spare parts and accessories.

The illustrations and technical data contained in this publication refer to the date of printing. ARAG reserve the right to modify the specifications and instructions at any time without notice.

For any requests for spare parts or after-sales service, please call your ARAG Dealer or call the ARAG Technical Service on +39 0522 622036.

## Table of Contents

---

|  |           |
|--|-----------|
| <b>Table of contents</b> .....                                       | <b>3</b>  |
| <b>Introduction</b> .....  | <b>4</b>  |
| <b>Composition of Kit</b> .....                                      | <b>4</b>  |
| <b>Overall dimensions</b> .....                                      | <b>5</b>  |
| <b>Technical and operating particulars</b> .....                     | <b>5</b>  |
| <b>Main assembly diagram</b> .....                                   | <b>6</b>  |
| <b>Control panel illustration</b> .....                              | <b>6</b>  |
| <b>Description of keys and symbols</b> .....                         | <b>7</b>  |
| <b>Control keys</b> .....  | <b>7</b>  |
| <b>Adjustment keys</b> .....   | <b>8</b>  |
| <b>User programming</b> .....  | <b>10</b> |
| <b>Introduction</b> .....  | <b>10</b> |
| <b>Calculating the wheel constant</b> .....                          | <b>10</b> |
| <b>Wheel constant menu</b> .....                                     | <b>11</b> |
| <b>Manual setting</b> .....  | <b>11</b> |
| <b>Automatic setting</b> .....                                       | <b>11</b> |
| <b>Variation in the density factory of the product sprayed</b> ..... | <b>12</b> |
| <b>Density programming menu</b> .....                                | <b>12</b> |
| <b>Automatic density calibration</b> .....                           | <b>12</b> |
| <b>Nozzle delivery rate</b> .....                                    | <b>13</b> |
| <b>Settings preliminary to treatment</b> .....                       | <b>13</b> |
| <b>Field number</b> .....  | <b>13</b> |
| <b>Resetting the field counters</b> .....                            | <b>14</b> |
| <b>Setting the amount of liquid placed in the tank</b> .....         | <b>14</b> |
| <b>Filling up by means of the flowmeter</b> .....                    | <b>14</b> |
| <b>Selecting the nozzle</b> .....                                    | <b>14</b> |
| <b>Valves with calibrated returns</b> .....                          | <b>15</b> |
| <b>Setting the calibrated returns</b> .....                          | <b>16</b> |
| <b>Treatment with automatic control</b> .....                        | <b>16</b> |
| Setting the litres/hectare to distribute .....                       | <b>16</b> |
| Setting the distance between rows .....                              | <b>16</b> |
| <b>Starting treatment in automatic</b> .....                         | <b>17</b> |
| <b>Treatment with manual control</b> .....                           | <b>17</b> |
| <b>Foam marker</b> .....   | <b>17</b> |
| <b>Displaying the counters</b> .....                                 | <b>18</b> |
| <b>Printing the counters</b> .....                                   | <b>18</b> |
| <b>Operating errors</b> .....  | <b>19</b> |
| <b>Appendix</b> .....  | <b>21</b> |
| <b>Relationship between ISO nozzle type and delivery rate</b> .....  | <b>21</b> |
| <b>Troubleshooting</b> .....   | <b>22</b> |
| <b>Terms of warranty</b> .....                                       | <b>23</b> |

## Introduction

---

BRAVO30X is a computer capable of controlling distribution of chemical products on sprayers equipped with valve control unit from 1 to 5 section valves. It is composed of a control panel, to be kept within the operator's reach, allowing control of all the valves.

BRAVO30X can also operate in manual mode; in this case the litres/hectare adjustment is made using the adjustment keys. If necessary, it is possible during automatic spraying to adapt delivery to treat aread of concentrated growth, temporarily or increasing or decreasing the dosage by  $\pm 50\%$ .

The large display of the BRAVO30X allows the operator to keep a constant eye on all data relating to the operation in progress, e.g. speed of the vehicle, the litres/hectare sprayed, total surface area treated and the quantity of liquid sprayed.

## Technical and operating particulars

---

| Description                        | Value                                 |
|------------------------------------|---------------------------------------|
| Display                            | custom LCD, backlit blue              |
| Power supply voltage               | 12 Vdc $\pm 10\%$                     |
| Consumption (not including valves) | 200 mA                                |
| Working temperature                | 0° $\div$ +70 °C                      |
| Distance travelled                 | 0.001 $\div$ 9999 km                  |
| Working time                       | 1min $\div$ 9999 ore                  |
| Speed                              | 0.1 $\div$ 99.9 km/h                  |
| Liquid delivered per hectare       | 1 $\div$ 1999 l/ha                    |
| Surface area treated               | 0.001 $\div$ 9999 ha                  |
| Liquid delivered                   | 1 $\div$ 99999 litres                 |
| Wheel circumference                | 0.01 $\div$ 999.99 cm                 |
| Boom width                         | 0.01 $\div$ 99.99 m                   |
| Number of sections                 | 1 $\div$ 5 (BRAVO305)                 |
| Flow-meter constant                | 1 $\div$ 99999 pulses/litre           |
| Digital signals                    | square wave<br>max 1500 pulses/second |
| Sensor power supply output         | Bravo power supply                    |

---

## Main assembly diagram

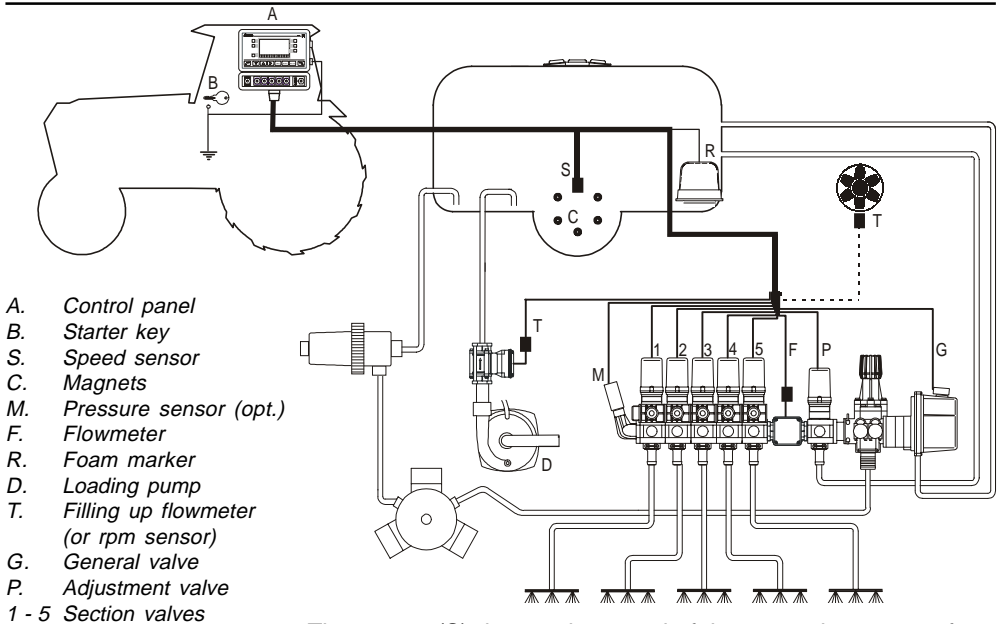

fig.1 assembly diagram

The sensor (S) detects the speed of the tractor by means of the magnets (C) and at the same time sends the data to the flow-meter (F) and/or pressure transducer (M) so that the control panel (A) can handle the control unit.

## Illustration of control panel

BRAVO30X has a large backlit multifunction display on which the user can display all the data defining the treatment in progress.

6 function keys at the side of the display allow the user to view and set the distribution parameters on the display, together with the other keys on the panel.

Below, the function keys are identified by the names F1...F7.

### Description of keys and symbols

The following is the list of the functions provided by the keys and the meanings of the symbols shown on the display:

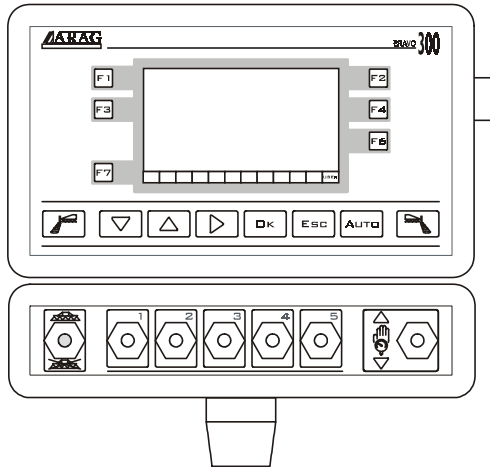



















fig.2 BRAVO305 control panel

## Control keys





|   |   |
|---|---|
| <b>F1</b>   | Distribution value setting  |
| <b>F2</b>   | Alternates display of the following data on the display: <ul style="list-style-type: none"> <li> Distance travelled</li> <li> Time worked</li> <li> Surface area treated</li> </ul>  |
| <b>F3</b>   | Access to the user programming menu   |
| <b>F4</b>   | Alternates display of the following data on the display : <ul style="list-style-type: none"> <li> Tank level</li> <li> Liquid distributed</li> <li> Battery voltage</li> </ul> |
| <b>F6</b>   | Alternates display of the following data on the display : <ul style="list-style-type: none"> <li> Flow-rate</li> <li> Pressure</li> <li> Rpm</li> </ul>                        |
| <b>F7</b>   | Allows nozzle selection   |
|  | Activates the left-hand side of the foam marker   |
|  | Activates the right-hand side of the foam marker  |

|   |  |
|---|--|
|  | Selects automatic or manual operation  |
|  | Increase key<br>In Manual mode: Increases the quantity for distribution<br>In Automatic mode :Increases the quantity for distribution in steps of 5% |
|  | Decrease key<br>In Manual mode: Decreases the quantity for distribution<br>In Automatic mode :Decreases the quantity for distribution in steps of 5% |
|  | Opens/Closes main valve  |
|  | Controls opening/closing of sections   |
|  | Increase/Decrease of quantity for distribution   |

N.B.: For correct operation, if the number of switches on the control panel is different from the number of section valves, connect the cables as shown in the table below:

| N Sections | Switches to be used | Cables to be connected |
|------------|---------------------|------------------------|
| 2          | 2, 4                | 2, 4                   |
| 3          | 2, 3, 4             | 2, 3, 4                |
| 4          | 1, 2, 4, 5          | 1, 2, 4, 5             |

### Adjustment keys

|   |   |
|---|---|
|  | Increases the digit of the value for modification |
|  | Decreases the digit of the value for modification |
|  | Moves on to the next digit                        |
|  | Confirms the value entered                        |
|  | Exits without modification                        |

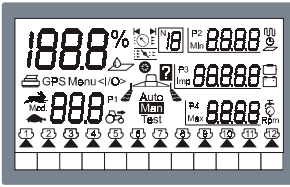

Fig.3  
Display test

**Switching on**

To activate BRAVO30X, position the starter key on "start"; BRAVO30X performs a display test, lighting up all the symbols (fig.3). After two seconds it displays the software release (fig. 4) and then switches to the main menu page (fig. 5).



Fig.4  
Software release

**Setting the contrast**

To modify the display contrast, press the and keys to increase or and to decrease.

Distribution

Number of active field

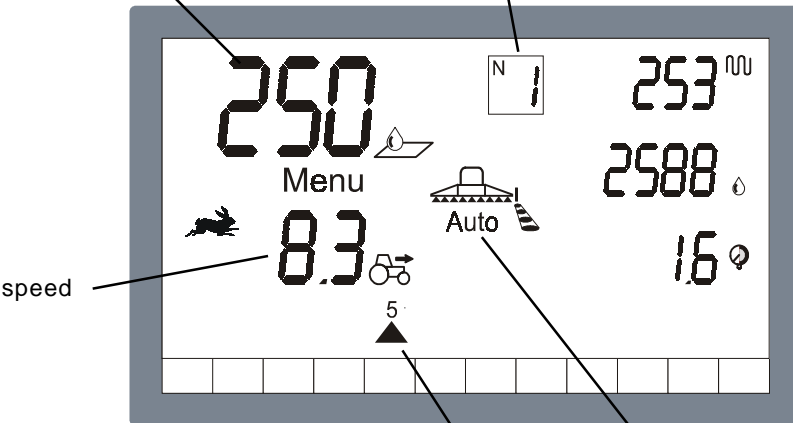

tot. distance  
tot. time  
tot. surface area  
battery voltage  
liquid in tank  
tot. liquid distr.  
Flow-rate  
Pressure  
rpm

Treatment data display

Man/Auto Indicator

Nozzle type

Fig.5  
Main menu page



### Introduction

Before starting treatment, some settings are necessary to inform the BRAVO30X about the characteristics of the vehicle on which it is installed (by means of the wheel constant), the characteristics of the liquid distributed (by means of the density), the type of flow-meter connected and the type of nozzle fitted.

### Calculating the wheel constant

It may be necessary to change the wheel on which the speed sensor magnets are installed, or the vehicle on which the sensor itself is installed, meaning that the circumference of the wheel changes.

In this case the constant on the BRAVO30X has to be changed to allow it to measure the distance travelled correctly, and thus make a correct calculation of the quantity of liquid delivered per unit of surface area.

The wheel constant is the distance the vehicle travels for each pulse received from the speed sensor.

The following is the **procedure for calculating the wheel constant:**

**Measuring the distance travelled in 10 turns of the wheel the speed sensor is installed on** (with the tyres inflated at working pressure).

This is the **formula to calculate the wheel constant:**

$$\text{Wheel Constant} = \frac{\text{Space travelled (m)} \times 10}{\text{number of magnets}}$$

Example:

- space travelled in 10 turns of the wheel = **25.4 m**
- number of magnets installed = **10**

The wheel constant is:

$$\text{Wheel Constant} = \frac{25.4 \times 10}{1} = 25.4$$

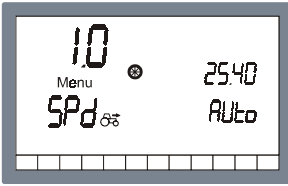

Fig.6  
Wheel constant display

### Wheel constant menu

To modify the wheel constant, the user programming menu must be accessed by pressing the **[F3]** key until the screen shown on the left (menu 1.0) appears.

### Manual setting

The **[F4]** key can be pressed to insert the value calculated for the wheel constant directly: use the modification keys to change and confirm the new value (the value set on the display is 25.40 cm/pulse).

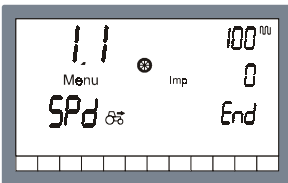

Fig.7  
Automatic setting of wheel constant

### Automatic setting

BRAVO30X is able to calculate the wheel constant automatically, on the basis of the number of pulses received from the speed sensor, when a distance of known length is travelled.

To carry out automatic the constant setting correctly, proceed as follows:

- 1) Prepare the tractor with the tank 50% full (the test can be carried out with just water ).
- 2) Drive the tractor to the start of the straight track of known length and stop.
- 3) If the length of the track is different from that set, press **[F2]** and use the modify keys to enter the new value.
- 4) Press the **[F5]** key beside the word AUtO and drive along the track.
- 5) At the end of the track, stop the tractor and press the **[F5]** key: BRAVO30X calculates the wheel constant automatically and shows it on the display.

N.B.: The test should be carried out on ground of medium hardness. If distribution is on very soft or very hard ground, the difference in wheel diameter may lead to a difference in the wheel speed reading, with a consequent error in calculation of the distribution.

In this case, the wheel constant setting procedure should be repeated.

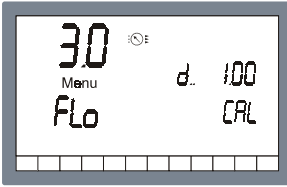

Fig.8  
Density factor programming menu

### Variation of the density factor of the product delivered

When distributing products other than water (e.g. liquid fertilisers) the values read by means of the blade or turbine flow-meter may be inaccurate, causing errors on distribution. To overcome this problem, it is possible to modify a density factor which acts as multiplier on the values read by the flow-meter.

N.B.: The ARAG ORION model flow-meter is unaffected by this problem.

### Density factor programming menu

This menu is accessed from the main display screen by pressing the **[F3]** key for one second.

Use the **[△]** **[▽]** keys to locate on menu 3.0 shown on the left.

To modify the value of the density factor, press **[F4]** and use the modification keys (in the example, the factor is 1.00).

Press **[OK]** to confirm the value and exit or **[ESC]** to exit without modifying.

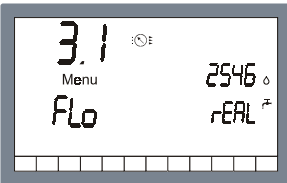

Fig.9  
Automatic density calibration

### Automatic density calibration

The automatic density calibration procedure is carried out as follows:

- 1) Fill the tank with a known quantity of water
- 2) Reset the field data (page 14)
- 3) Distribute the product (page 16)
- 4) Calculate the amount of liquid distributed
- 5) Press **[F3]** to access the programming mode
- 6) Select menu 3.0
- 7) Perform the calibration

Calibration is started by pressing the **[F6]** key beside the word **CAL** (fig.8).

The screen shows the amount of liquid counted by the computer (in the example 2546 litres) during the last distribution, with the density value currently memorised.

Press the **[F6]** key beside the word **REAL**, and enter the quantity of liquid actually delivered during the treatment: the computer will calculate and memorise the new density factor.

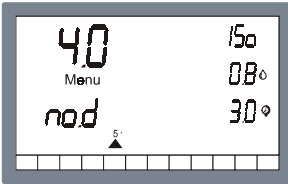

Fig.10  
Modifying the nozzle data

### Nozzle Flow-Rate

If the computer is not connected to a pressure transducer, it may still be able to calculate and display the pressure on the basis of the flow-rate value measured by the flow-meter and the nozzle flow-rate data.

N.B. For correct pressure measurement, the nozzles must be in good condition, so that the real flow-rate is the same as the rated flow-rate.

If the operator is using nozzles which do not correspond to the ISO standard, he can modify the default settings of the eleven preset ISO nozzles.

This menu is accessed from the main menu screen by pressing the **F7** key for one second.

Use the **△** **▽** keys to locate on menu 4.0 (fig.10).

As can be seen, nozzle number 5 (red colour ISO 11004) is set to deliver 0.8 litres/minute at a pressure of 3.0 bar. The operator can press the **F4** and **F6** keys to modify the flow-rate and pressure value as appropriate to the nozzle in use.

To restore the ISO value, simply press the **F2** key and confirm the values with the **OK** key.

See appendix for table 1, showing the relationship between pressure and flow-rate for ISO nozzles.

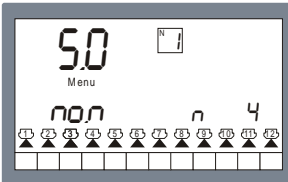

Fig.11  
Modifying the nozzle data

### Number of Nozzles

**(467302 and 467304 versions only for 2- 4-way orchard sprayers)**

If the computer is installed on an orchard sprayer it is possible to specify, according to requirements, the number of nozzles used on each spray boom. By doing this the calculation of pressure is more accurate if there is no pressure transducer or the regulation is more stable if it is done referring to the data read by the transducer.

You can access this menu from the main menu, press the **F7** key for one second.

With keys **△** **▽** go to menu 5.0 (fig.11).

Press the **F2** key and the keys **△** **▽** to select the spray boom for which you want to set the number of nozzles.

Press key **F4** to access data modification and set the number of nozzles wanted by pressing keys **△** **▽**.

Press **OK** to confirm the data and exit or **ESC** to exit without changing the data.

## Settings preliminary to treatment

---

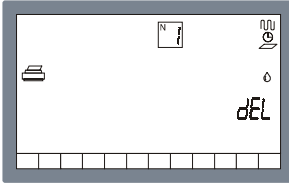

Fig.12  
Resetting the counters

Before each treatment, the following operations should be carried out:

- 1) Set the field number
- 2) Reset the field counters
- 3) Set the amount of liquid put in the tank
- 4) Select the nozzle to be used.
- 5) Set the distribution value.

### Field number

BRAVO30X automatically records of the space travelled, time worked, surface area treated and liquid distributed data. BRAVO30X offers the possibility of nineteen partial counter units (known for the sake of simplicity as fields), to which the treatment counts can be addressed.

N.B.: Field number 0 contains the device's absolute counter and cannot be deleted.

To set the field number, keep the **F2** field pressed until the screen shown on the left appears.

The **▽** **△** keys can be pressed to select the number of the field; pressing **OK** confirms the number selected.

Pressing **ESC** aborts the selection made and returns to the main menu screen.

### Resetting the field counters

The **F6** key can be pressed to reset the display of one or more of the counters relating to the field currently selected; the count selected and the **dEL** symbol flash: pressing **OK** confirms the reset, or pressing **ESC** exits from the deletion mode.

N.B.: the counts relative to the symbols which are lit up are reset (in the example in fig. 12, the space travelled, time worked, surface area treated and liquid distributed counts are reset). To change count, press **F2**.

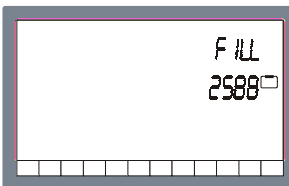



Fig.13:  
Setting the tank filling level

### Setting the amount of liquid placed in the tank

BRAVO30X is able to calculate the amount of liquid left in the tank starting from the filling value and subtracting the liquid distributed from it. The computer also warns when the liquid level reaches the low threshold by sounding a beeper and by flashing the tank level indicator light .

The amount of liquid placed in the tank is programmed by pressing **F4** until the screen on the left is displayed.

Pressing the **F2** keys sets the tank level at the maximum filling level envisaged by the manufacturer.

To set a level different from the maximum filling value, press **F4** so that the liquid in tank value flashes and use the modification keys to change it.

### Filling the tank by means of the flowmeter

So the computer stores the exact quantity of liquid put into the tank, it is possible to fill the tank up with the specific flowmeter.

To do this, access the filling up menu by pressing the **F4** key on the main screen page until the screen page shown in Fig. 13 appears.

Now fill the tank up by starting the loading pump.

The computer shows in real time the quantity of liquid that has been put inside the tank which is added to the liquid that is already inside it, until the loading pump stops. (In the example given in Fig. 13 there are 2,588 litres inside the tank).

Once filling up is finished, return to the main screen page by pressing key **ESC**.

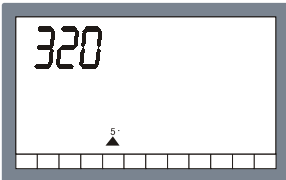

Fig.14:  
Setting the tank filling level

### Selecting the nozzle

The user will have selected the nozzle to be used for the treatment on the basis of the speed at which the treatment is to be performed and the quantity of liquid per hectare to be used. This information is fundamental if using a pressure transducer to regulate the distribution, but with a flow-meter alone, it is only used to correct display of the pressure value calculated by the computer (it does not affect the distribution setting).

Nozzle setting is begun by pressing the **F7** function key for one second, until the screen shown in fig14 appears.

A flashing **5** symbol appears in the bottom of the screen, indicating the type of nozzle selected (in the example, number 5).

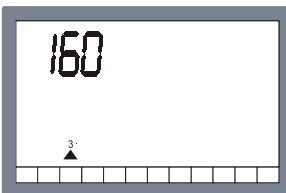

Fig.15:  
ISO11002 nozzle selection

The flashing symbol is underneath coloured indicators representing the standard ISO nozzle colours.

If the nozzle chosen is ISO, e.g. ISO11002 (yellow), simply bring the flashing symbol above the rectangle of the same colour (yellow) with the **△** **▽** keys.

Press **α<** to confirm the new nozzle and exit or **ESC** to abort.

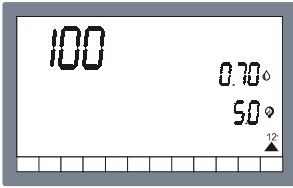

Fig.16:  
"USER" nozzle

If the operator wishes to use a non-ISO nozzle but still be able to select the ISO nozzles directly, he can access a nozzle known as "USER" in which he can set the data of the nozzle in use.

To do this, display the nozzle selection screen as described earlier and bring the flashing nozzle symbol into the <sup>(12)</sup> position (fig.16); the display will contain the indication of the number of litres per minute delivered by the nozzle at a given pressure (in the example, the nozzle delivers 0.70 l/min at a pressure of 5.0 bar).

The number in the top left-hand corner indicates the distribution value (in litres/hectare) which the computer will maintain with the nozzle selected. To change the last value set, simply press the **[F1]** key and use the modification key.

N.B.: for each nozzle, BRAVO30X always sets the last distribution value used with that nozzle.

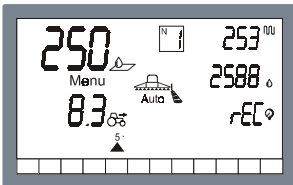

Fig.17: Requesting calibration of the calibrated returns

### Valves with calibrated returns

If the unit is fitted with valves complete with calibrated return, and if BRAVO30X has been programmed for operation with calibrated return during installation of the system, at each nozzle change the flashing message *rEC* appears on the right of the display.

This reminds the user that he has to perform a new procedure to adjust the calibrated returns.

N.B.: The calibrated return adjustment procedure is necessary to allow the computer to adjust and display the distribution correctly when one or more section bars are closed.

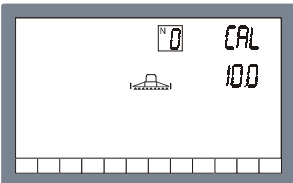

Fig.18:  
Setting the calibrated returns

### Setting the calibrated returns

Setting of the calibrated returns is started by keeping the **[F6]** function key pressed for 1 second (fig.18).

Open all the section valves and the master valve; the flow-rate value currently read by the flow-meter (10.0 in the example) is displayed beside **[F4]**.

Close the first section valve: the flow-rate information before the closure is frozen on the display, while the flow-rate value currently read by the flow-meter (with the section valve discharging on the calibrated return), given by the sum of the flow-rates to the boom and the tank, by means of the calibrated

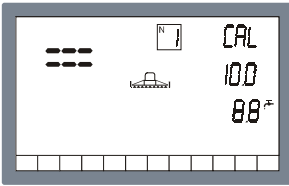

Fig.19:  
Adjusting section n.1

return is shown beside .

(In the example if fig. 19, this is 8.8).

At this point the calibrated return has to be adjusted so that the two values are the same: when they coincide the section valve can be reopened and the operation can be repeated for all the other section valves.

Adjustment of the calibrated return is assisted by a beeper and indicator lights; as the calibrated return approaches the optimal setting, the intermittent sound emitted by the beeper becomes quicker and quicker, until it becomes continuous (setting OK). During the adjustment three flashing segments indicate whether the flow-rate generated by the calibrated return is too high or too low (in the example, it is too low).

Caution: the section valves must be closed one at a time: if more than one section valve is closed simultaneously, the display shows a dash in the position of the field; otherwise, the number of the closed section valve appears.

Press  to exit from the calibrated return setting procedure.

## Starting the treatment

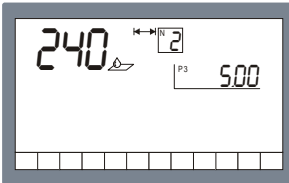



Fig.20:  
Setting l/ha for distribution

### Treatment controlled in automatic mode



#### Setting the litres/hectare to distribute

Prior to each distribution you first have to make sure that the distribution set is correct: press  until the value to distribute flashes (Fig.20) and use the modification keys to change and confirm the value.

#### Setting the distance between rows

(467302 and 467304 versions only for the 2- and 4-way orchard sprayers)

In the case of the orchard sprayer versions 467302 and 467304 you will also have to set the distance between the rows so that the computer can then make the correct adjustments. By pressing the  key followed by the modification keys, you can select one out of the nine storable distance values.

If necessary, it is possible to access modification of one of these values by pressing the  key and setting another value by pressing keys  and .



Press  to confirm the data and exit or press  to exit without changing the data.





Fig.21:  
Controls for varying the distribution.

### Start of treatment in the automatic mode

To perform a treatment in automatic mode, proceed as follows:

- 1) Check that the **Auto** symbol in the centre of the display has illuminated, or press the **AUTO** key so that it appears.
- 2) Open the section valves using the relative keys.
- 3) Go to the beginning of the field for treatment.
- 4) Open the master valve.

During automatic operation, BRAVO30X keeps the litres per hectare applied constant at the value set previously. The control keys can be provided to make a temporary variation in the volume to be distributed (fig.21). The display shows the percentage variation of the volume to be distributed in alternation with the volume actually applied. To cancel the temporary variation, return the percentage variation to zero.

### Treatment controlled in manual mode

To perform a treatment in manual mode, proceed as follows:

- 1) Check that the **Man** symbol has illuminated in the centre of the display or press the **AUTO** so that it appears.
- 2) Open the section valves using the relative keys.
- 3) Go to the beginning of the field for treatment.
- 4) Open the master valve.
- 5) Use the control keys to modify the value of the amount to be distributed (fig.21).

Attention: in the versions for the 467302 and 467304 orchard sprayers it is also necessary to set the distance between rows so the computer can display the correct data (page16).

### Foam marker

If the foam marker kit is installed, the computer is able to control it in 2 modes:

Manual mode:



Press the  or  keys to activate the side of the foam marker required, and press the same key again to stop it. N.B.: the foam marker is disabled automatically when the master switch is closed.





Fig.22:  
Left-hand side foam marker active .

Automatic mode:

If the foam marker function has been set for automatic operation, the foam marker stops automatically when the master valve is closed and restarts from the opposite side when it is reopened.

The active side of the foam marker is indicated by the flashing row symbol above the boom symbol (fig.22).

To stop the foam marker, press the foam marker key  or  relating to the active side.

After a manual stoppage of the foam marker, next time the master valve is opened the row symbols above the boom symbol flash simultaneously to instruct the operator to activate the side of the foam marker required.

## Consulting the treatment data

---

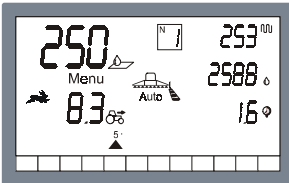





Fig.23  
Counts



### Displaying the counts

Once the treatment is complete, the operator can consult the data relating to it.

The counts made available by the computer are:

|   |                      |            |
|---|----------------------|------------|
|  | Space travelled      | (Km)       |
|  | Time worked          | (hh.mm)    |
|  | Surface area treated | (hectares) |
|  | Liquid distributed   | (litres)   |

The counts refer to the number of the field currently selected.

When the  and  keys are pressed, the symbols illustrated above appear beside the keys in succession.

The figure beside the symbol is the value of the count.

In the example in fig. 23, for field number 1, the distance travelled is 253 Km, while the liquid distributed amounts to 2588 litres.

N.B.: the distance count only works with the master valve closed. This count can therefore be used to measure the distance between the field and the operator's home, or to measure the length of a field.

N.B.: the time worked count can be stopped or started by pressing the  key.

When the count is enabled, the  symbol flashes.

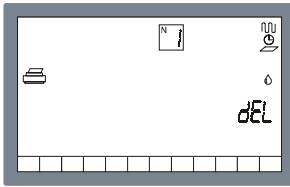

Fig.24  
Printing the treatment data

### Counters printout

If the printer (code 467001) or the download software of data on the personal computer (code 467002) is connected to BRAVO30X, it will be possible to print the data of the field counters.

Press keys **F2** until the screen page depicted in Fig. 24 appears.

Once you have selected the field wanted, press the **F3** key to have the printout of the treatment data.

With the counters' printout you can glean the following information:

#### --- TREATMENT DATA -----

|                   |               |
|-------------------|---------------|
| Area:             | 73.0700 ha    |
| Consumption:      | 10040L        |
| Average distrib.: | 137.4 L/ha    |
| Distrib. set:     | 100.0 L/ha    |
| Nozzle:           | 3             |
| Time:             | 3.009 hhhh.mm |
| Area per hour:    | 0.0023        |

#### --- GUIDELINE DATA -----















|          |              |
|----------|--------------|
| Distance | 2.0330 Km    |
| Time     | 0.15 hhhh.mm |

#### --- OTHER DATA -----









|            |              |
|------------|--------------|
| Total time | 3.32 hhhh.mm |
|------------|--------------|

## Operating errors

BRAVO30X monitors all distribution parameters constantly. In case of a malfunction, the following error messages appear on the display:

| Nr | ERROR MESSAGE   | CAUSE  | REMEDY  |
|----|---|--|---|
| 1  |  and    | <ul style="list-style-type: none"> <li>- During treatment it is not possible to distribute the quantity of liquid per unit of area set</li> </ul>  | <ul style="list-style-type: none"> <li>- Reduce vehicle speed</li> <li>- Use nozzles capable of higher delivery rates</li> <li>- Increase the maximum working pressure</li> </ul>                               |
| 2  |  and    | <ul style="list-style-type: none"> <li>- During treatment it is not possible to distribute the quantity of liquid per unit of area set</li> </ul>  | <ul style="list-style-type: none"> <li>- Increase vehicle speed</li> <li>- Use nozzles capable of lower delivery rates</li> </ul>   |
| 3  |  and    | <ul style="list-style-type: none"> <li>- In AUTO mode the Bravo 300 is not receiving the flow-meter signal</li> <li>- In AUTO mode the master valve switch is on ON but the control unit is not receiving any liquid</li> </ul>      | <ul style="list-style-type: none"> <li>- Check the connection between the flow-meter and the Bravo 300</li> <li>- Check that the pump is operating</li> <li>- Check that there is liquid in the tank</li> </ul> |
| 4  |  and    | <ul style="list-style-type: none"> <li>- In AUTO mode the Bravo 300 is not receiving the speed sensor signal</li> <li>- In AUTO mode the master valve switch is on ON but the machine is not moving</li> </ul>                       | <ul style="list-style-type: none"> <li>- Check the connection between the speed sensor and the Bravo 300</li> <li>- Put the machine in motion</li> </ul>  |
| 5  |  and  and  | <ul style="list-style-type: none"> <li>- In AUTO mode the Bravo 300 is not receiving the speed sensor and flow-meter signals</li> <li>- In AUTO mode the master valve switch is raised but the machine is at a standstill</li> </ul> | <ul style="list-style-type: none"> <li>- Check the Bravo 300's connections to the speed sensor and flow-meter</li> <li>- Put the machine in motion and start up the pump</li> </ul>                             |
| 6  |    | <ul style="list-style-type: none"> <li>- While regulating balancing-valves, Bravo 300 surveys a flow-rate, that is too low</li> </ul>  | <ul style="list-style-type: none"> <li>- Check connection between flow-meter and Bravo 300</li> <li>- Check flow-meter constant's set-up</li> </ul>   |
| 7  |    | <ul style="list-style-type: none"> <li>- While setting wheel constant, Bravo 300 didn't get the correct pulses to calculate the constant</li> </ul>  | <ul style="list-style-type: none"> <li>- Repeat wheel constant's automatic set-up</li> </ul>  |
| 8  |    | <ul style="list-style-type: none"> <li>- After changing nozzle type, balancing valves must be adjusted</li> </ul>  | <ul style="list-style-type: none"> <li>- Adjust balancing valves</li> </ul>   |
| 9  |    | <ul style="list-style-type: none"> <li>- Liquid in tank is below reserve level</li> </ul>  | <ul style="list-style-type: none"> <li>- Fill the tank</li> </ul>   |

## Troubleshooting

| No | DEFECT  | CAUSE  | REMEDY   |
|----|---|--|--|
| 1  | The display does not show data  | -No power supply   | -Turn the starter key onto "Start"<br>-Check the connections on the power supply cable<br>-Check the main fuse   |
| 2  | It is not possible to control the valves  | -The valves are not connected<br>-Fuse blown                           | -Connect up the connector<br>-Check the main fuse  |
| 3  | The display does not show the speed   | -Faulty programming<br>-The signal is not arriving at the speed sensor | -Check the  programming<br>-Check the connections with the speed sensor<br>-Check the distance between magnets and sensor                 |
| 4  | The speed displayed is imprecise  | -Faulty programming  | .Check the  programming<br>.Check the no. of magnets<br>.Check the distance between magnets and sensor                                    |
| 5  | Display is unstable even at constant speed  | -Insufficient number of magnets  | -Increase the number of magnets  |
| 6  | Imprecise "  " display   | -Faulty programming  | -Check the programming the boom length<br>-Check the programming of the "Flow-meter constant" and the density<br>-Check the  programming |
| 7  | The " Tot.  " value displayed on the computer is different to the value of the hectares actually treated | -Faulty programming<br>-The meter has not been zeroed                  | -As for point no. 3<br>-Zero the " Tot.  " meter  |
| 8  | The " Tot.  " value displayed on the computer is different to the value of litres actually delivered     | -Faulty programming<br>-The meter has not been zeroed                  | -Check the programming of the "Flow-meter constant" and " Dens. "<br>-Zero the " Tot.  " meter  |

## Unit of measure

|                | <b>EU</b>    | <b>EU t</b> | <b>US</b>    |
|----------------|--------------|-------------|--------------|
| Surface        | Hectare (Ha) | Hectare(Ha) | Acre         |
| Dist. travell. | Km           | Km          | Mile         |
| Time           | Hours        | Hours       | Hours        |
| Capacity       | Litres       | Tons        | Gallons      |
| Voltage        | Volt         | Volt        | Volt         |
| Pressure       | bar          | bar         | psi          |
| Flow rate      | Litres/min   | t/min       | Gal/min      |
| Speed          | Km/h         | Km/h        | Miles/h      |
| Distribution   | Litres/Ha    | t/Ha        | Gal/Acre     |
| Sect.width     | metres       | metres      | feet         |
| Nozzle dist.   | metres       | metres      | inches       |
| Flow constant  | pulse/l      | pulse/t     | pulse/Gal    |
| Wheel const.   | metres/puls  | metres/puls | inches/puls. |
| Tank cap.      | Litres       | Tons        | Gallons      |
| P.T.O.         | rpm          | rpm         | rpm          |

## Relationship between ISO nozzle type and flow-rate

Table 1 shows the flow-rate value (expressed in litres/minute) measured at the pressure of 3bar, for the ISO nozzles.

| Color          | Code      | lt/min |
|----------------|-----------|--------|
| Orange         | ISO110011 | 0,40   |
| Dark green     | ISO110015 | 0,60   |
| Yellow         | ISO11002  | 0,80   |
| Blue           | ISO11003  | 1,20   |
| Red            | ISO11004  | 1,60   |
| Brown          | ISO11005  | 2,00   |
| Grey           | ISO11006  | 2,40   |
| White          | ISO11008  | 3,20   |
| Cambridge blue | ISO11010  | 4,00   |
| Light green    | ISO11015  | 6,00   |
| Black          | ISO11020  | 8,00   |

## Terms of warranty

---

1. ARAG guarantee BRAVO30X for a period of 12 months from the date of sale to the user customer (the freight bill of the goods shall bear witness to this).  
The parts composing the equipment, which at the unquestionable judgment of our Company turn out to be defective due to an initial defect in the material or manufacture, shall be repaired or replaced free of charge at the closest Service Centre in operation at the time of requesting the work. Exceptions to this are the expenses concerning:
  - transportation of the equipment to the Service Centre;
  - dismantling and reassembling of BRAVO30X from the machine;
2. Warranty does not cover:
  - transit damage (scratches, dents and the like);
  - damage due to faulty installation or initial defects from an insufficient or inadequate electrical system, or alterations deriving from environmental, climatic, or other conditions;
  - damage deriving from using unsuitable liquids;
  - failures caused by negligence, tampering, user incapability, or repairs made by non-authorized personnel;
  - installation and adjustment;
  - system references or convenience checks;
  - maintenance such as cleaning filters, nozzles, etc.;
  - what may be considered normal deterioration due to use;
3. The equipment shall be restored in the limits of time compatible with the organizational requirements of the Service Centre; the Units or components to be repaired or replaced shall have to first be washed and cleaned of the residues of the chemical products used;
4. Repairs made under warranty do not give rise to its extension or renewal
5. No one is authorized to change the terms and conditions of warranty or to issue other statements or writings
6. ARAG shall not be held liable for any damage caused to persons or things by failure or forced suspension of using the equipment
7. Parts replaced under warranty remain property of ARAG
8. For any controversy the Court of Reggio Emilia is the competent one.



42048 RUBIERA (Reggio Emilia) ITALY  
Via Palladio, 5/A  
Tel. 0522.622011  
Fax 0522.628944  
Home page: <http://www.aragnet.com>  
E-Mail: [info@aragnet.com](mailto:info@aragnet.com)

---

D20033.GB-m03 07/2005